



OWNER'S GUIDE



IMPORTANT

READ THIS IMPORTANT INFORMATION BEFORE USING YOUR STAND-UP PADDLEBOARD

DISREGARDING ANY OF THE SAFETY PRECAUTIONS AND INSTRUCTIONS CONTAINED IN THE OWNER'S MANUAL AND/OR ON THE PRODUCT MAY RESULT IN INJURY, INCLUDING THE POSSIBILITY OF DEATH.

- REVIEW THE WEIGHT CAPACITY LIMITATIONS OF THIS BOARD AND NEVER EXCEED IT. WWW.JIMMYSTYKS.COM
- ALWAYS WEAR A COAST GUARD APPROVED PERSONAL FLOTATION DEVICE (PFD).
- NEVER GO PADDLE BOARDING IN SEVERE WEATHER OR WATER CONDITIONS THAT MIGHT AFFECT YOUR ABILITY TO STEER THE BOARD OR RETURN TO SHORE.
- NEVER ALLOW MINORS TO USE THIS BOARD WITHOUT ADULT SUPERVISION.
- NEVER CONSUME ALCOHOL OR ANY OTHER SUBSTANCES THAT MAY IMPAIR YOUR COORDINATION, JUDGEMENT, OR ABILITY TO SAFELY PADDLE THE BOARD.
- NEVER USE THIS BOARD BEYOND YOUR SKILLS OR ABILITY.
- NEVER USE THIS PRODUCT AFTER SUNSET, BEFORE DAWN OR AT ANY TIME IN POOR LIGHTING.
- CHECK LOCAL LAWS AND REGULATIONS REGARDING PROPER AND SAFE USE OF THIS PRODUCT.
- NEVER USE THE VALVE WRENCH TO DEFLATE AN INFLATED BOARD.
- PRESSURE GAUGE WILL ONLY REGISTER PRESSURE ABOVE 10 PSI.
- DO NOT INFLATE SUP ABOVE 15 PSI.
- KEEP CLEAR OF SHARP OBJECTS AND/OR HEAT PRODUCING OBJECTS.

FOR WARRANTY INFORMATION, PARTS/ACCESSORIES, CALL
1-800-370-0745 OR CONTACT US THROUGH OUR WEB SITE,
WWW.JIMMYSTYKS.COM

TABLE OF CONTENTS

SECTION 1:	
IDENTIFYING SUP PARTS AND ACCESSORIES	PAGES 4 - 5
SECTION 2:	
PADDLEBOARD CARE AND MAINTENANCE	PAGES 6-7
SECTION 3:	
INFLATING & DEFLATING	PAGES 8 - 9
SECTION 4:	
VALVE TIGHTENING	PAGE 10
SECTION 5:	
JS ADJUSTABLE TRAVEL PADDLE	PAGE 11
SECTION 6:	
LEASH INSTALLATION	PAGE 12
SECTION 7:	
FIN INSTALLATION	PAGE 13
SECTION 8:	
CARRY & TRANSPORT GUIDELINES	PAGE 14
SECTION 9:	
INFLATABLE SUP REPAIRS	PAGE 15
SAFETY GUIDELINES	PAGE 16
LIMITED WARRANTY INFORMATION	PAGE 17
NOTES	PAGES 18-19

JimmyStyks.com

QUESTIONS/COMMENTS:
1-800-370-0745

IDENTIFYING STAND-UP PADDLEBOARD PARTS AND ACCESSORIES

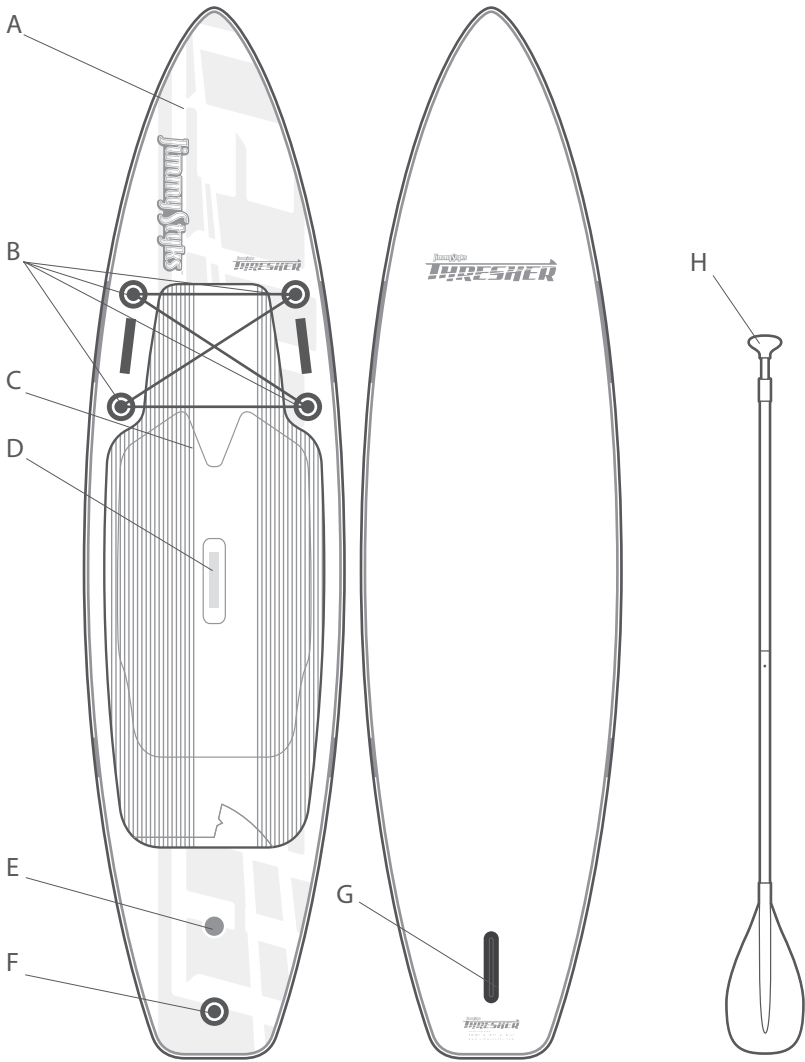

FOR WARRANTY INFORMATION, PARTS/ACCESSORIES, CALL
1-800-370-0745 OR CONTACT US THROUGH OUR WEB SITE,
WWW.JIMMYSTYKS.COM

SECTION 1

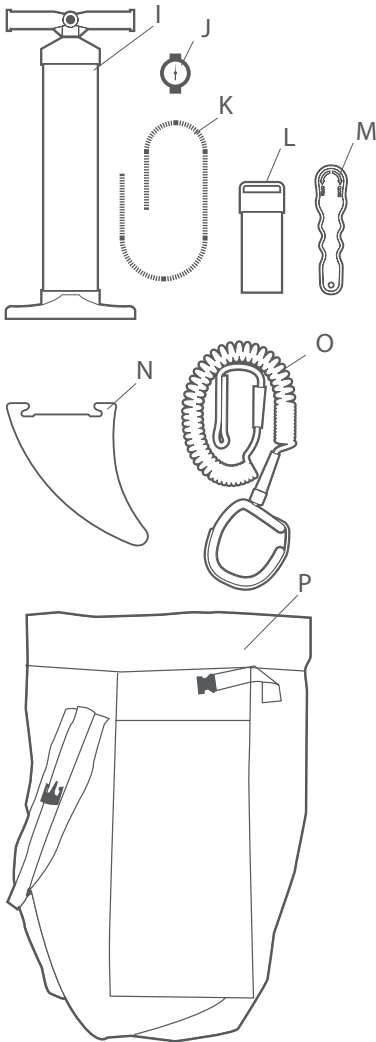

Jimmy Styks
THRESHER

INFLATABLE SUP
 10'8" x 31" x 5.875"

- A THRESHER Paddle Board
- B Bungee Rings & Cords
- C Traction Pad
- D Carry Handle
- E Air Valve
- F Leash D-Ring
- G Fin Clamp
- H JS Adjustable Travel Paddle
- I High Pressure Pump
- J Pressure Gauge
- K Air Hose
- L Repair Kit
- M Valve Wrench
- N Fin
- O Coil Leash
- P Board Tote

JimmyStyks.com

QUESTIONS/COMMENTS:
1-800-370-0745

PADDLEBOARD CARE AND MAINTENANCE



KEEP IN A WELL VENTILATED, SHADED AREA WHEN NOT IN USE.

Direct sunlight can damage a board if left exposed for a period of time. Heat can cause the air inside the board to expand beyond the internal pressure limits of the board. Keep your board in an area with good air flow and circulation. Leaving your board in a vehicle during the day (closed or open) elevates the risk for heat related damages.



OPTIMAL INFLATION IS 12-15 PSI. MAX PRESSURE IS 15 PSI.

Max pressure is 15 psi. Do not overinflate. If inflated in cooler early morning temperatures, inflate closer to the lower end of optimal inflation range. Inflating at a lower psi will allow for pressure expansion as the outside temperature warms during the course of the day.



REVIEW THE PROPER INFLATION & DEFLATION PROCEDURES IN THIS MANUAL.

Improper inflation and deflation of your inflatable sup may result in damage to the product and potential injury.



OVERINFLATING YOUR PADDLE BOARD OR USING IMPROPER INFLATION/DEFLATION TECHNIQUES IS NOT COVERED BY THE MANUFACTURER'S WARRANTY!

FOR WARRANTY INFORMATION, PARTS/ACCESSORIES, CALL
1-800-370-0745 OR CONTACT US THROUGH OUR WEB SITE,
WWW.JIMMYSTYKS.COM



DO NOT STORE YOUR BOARD IN A BOARD BAG FOR EXTENDED PERIODS OF TIME.

Board bags are intended for transportation protection, not full time storage. Prolonged storage of a wet board in a wet board bag will have adverse effects on the finish of your board, leading to the possibility of mold, and osmotic blisters. Storing your board in a board bag is not the same as placing it in the shade. Board bags will collect heat and potentially overheat your board.



RINSE SAND AND SALTWATER DEPOSITS FROM YOUR BOARD AFTER USE.

Sun, sand and saltwater will degrade any man-made material over time. Rinse off sand and saltwater deposits from your paddle board with fresh water and store in a cool, dry environment after each use.



MAINTAIN THE HIGH PRESSURE PUMP REGULARLY.

Please be sure that before and during use, the pump is fully lubricated with oil.

To lubricate, open the top and spread a thin layer of oil or grease on the gasket and tube.

Regularly clean the air filter located inside the top.

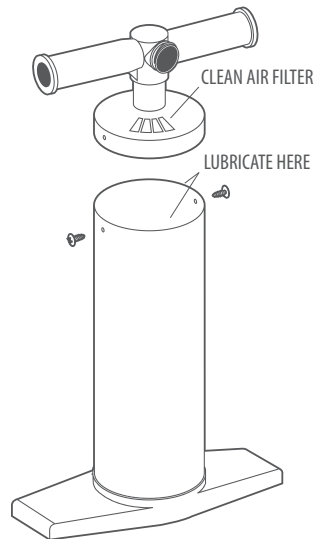

INFLATING & DEFLATING

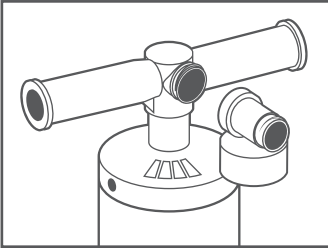

SUP INFLATION

SETTING UP PUMP

Attach pressure gauge to pump. Begin with pressure gauge dial facing the ground and twist clockwise 180 degrees until dial is securely fastened and facing upward.

Fasten air hose to pressure gauge.

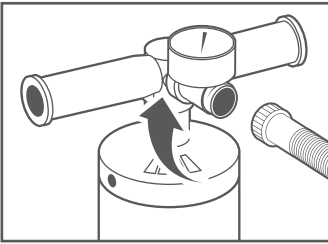

INFLATING SUP

Locate the air valve on tail section of the board deck.
Open valve cap.

Turn the **colored** valve pin counter-clockwise to the "UP" position. A valve pin in the "UP" position will freely push down and spring back to the start position when depressed.

Connect air hose to air valve and twist 90° to secure the connection.

Inflate to 12-15 psi.

Disconnect air hose from valve.

The valve pin will prevent air from escaping when in the "UP" position.

Close valve cap.

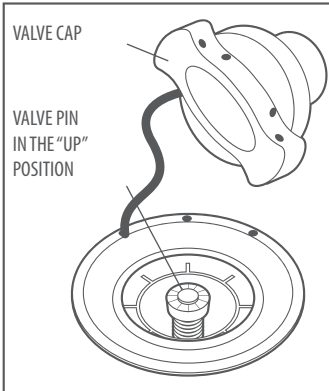

FOR WARRANTY INFORMATION, PARTS/ACCESSORIES, CALL
1-800-370-0745 OR CONTACT US THROUGH OUR WEB SITE,
WWW.JIMMYSTYKS.COM

SUP DEFLATION

Open valve cap.

Depress **colored** valve pin and turn clockwise to lock the pin in the "DOWN" or open position.

Allow air to freely escape Inflatable SUP for a few minutes.

Beginning at the nose, tightly roll up Inflatable SUP to force remaining air through the air valve.

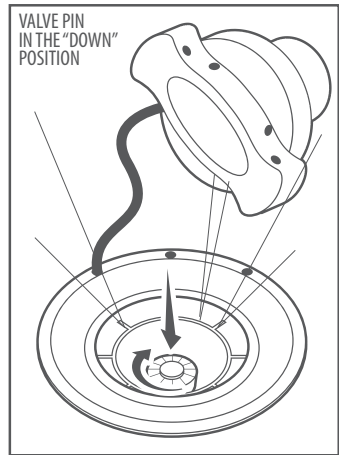

TROUBLE SHOOTING LEAKING SUPS

SUP NOT INFLATING or AIR ESCAPING SUP WHILE INFLATING

Verify the valve pin is in the "UP" position. "UP" keeps air in. "DOWN" allows air out.

Verify the air hose is securely fastened to the air valve.

The air valve may be loose. Refer to "VALVE TIGHTENING" in this manual.

Check for tears and/or cracks. This is best performed in water. Submerge the sup and look for streams of air bubbles. If a large body of water is not available, try a spray bottle filled with water and dish soap. Spray the board along the seams and look for billowing soap bubbles. If a tear/hole is located, refer to "INFLATABLE SUP REPAIRS" in this manual.

If none of these tips resolve the issue, contact us online through our live chat or email at www.jimmystyks.com.

JimmyStyks.com

QUESTIONS/COMMENTS:
1-800-370-0745

VALVE TIGHTENING

SECTION 4



NEVER USE THE VALVE WRENCH WHEN SUP IS PRESSURIZED.

Occasionally, the valve on your inflatable SUP may become loose. If the valve flange freely spins when opening the valve cover or you detect air leaking from the valve area, tightening may be required. Using the included valve wrench, tighten valve in a clockwise motion until hand tight.

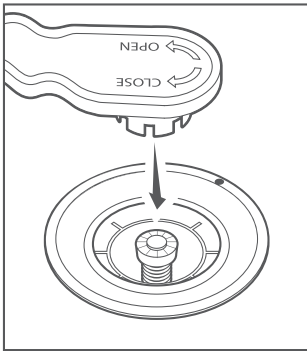

VALVE WRENCH

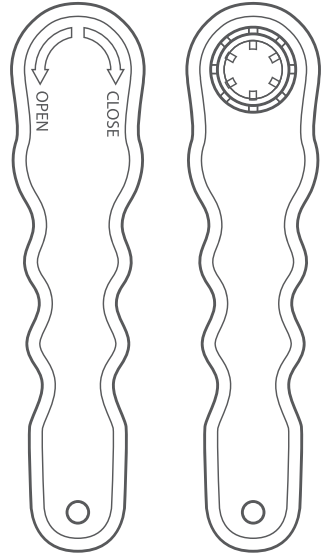

THE VALVE WRENCH IS NEVER NEEDED IN SUP DEFLATION.

Using the valve wrench while the sup is pressurized can lead to damage to the product and possible injury. Never use the valve wrench to deflate a sup. Refer to "INFLATING & DEFLATING" in this manual for proper inflation/deflation techniques.

FOR WARRANTY INFORMATION, PARTS/ACCESSORIES, CALL
1-800-370-0745 OR CONTACT US THROUGH OUR WEB SITE,
WWW.JIMMYSTYKS.COM

JS ADJUSTABLE TRAVEL PADDLE SECTION 5

PADDLE ASSEMBLY

The Inflatable SUP includes our JS Adjustable Travel Paddle. For carrying convenience, the paddle can be separated into two smaller halves. Our JS WATER GEAR adjustable clamp allows for non-permanent sizing on-the-go.

When connecting the two shafts of the paddle, make sure that the "Jimmy Styks™" logo side of the blade is aligned with the adjustable clamp lever.



BE CAREFUL TO NOT PINCH FINGER TIPS WHEN ASSEMBLING THE PADDLE.



WATER MAY ENTER THE SHAFT OF THE TRAVEL PADDLE CAUSING THE PADDLE TO SINK.

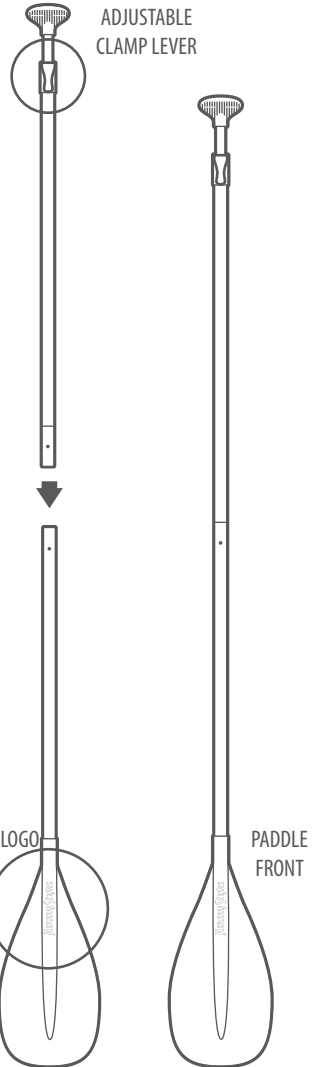

JimmyStyks.com

QUESTIONS/COMMENTS:
1-800-370-0745

LEASH INSTALLATION

SECTION 6

COIL
LEASH

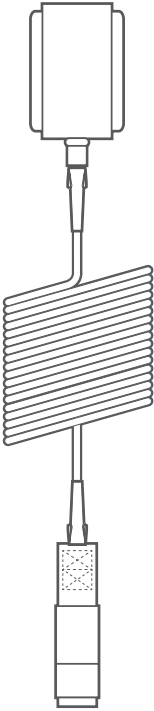

STEP 1

PULL LEASH LOOP THROUGH EYELET.

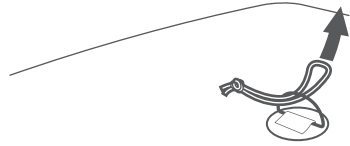

STEP 2

PULL KNOT THROUGH LOOP AND
PULL TIGHT.

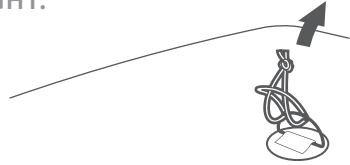

STEP 3

OPEN VELCRO CUFF AND ATTACH
LEASH TO LEASH LOOP.

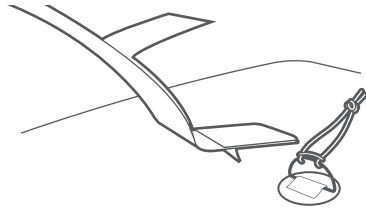

Jimmy Styks™ recommends that you remove your leash after use to prevent unintentional snagging.

FOR WARRANTY INFORMATION, PARTS/ACCESSORIES, CALL
1-800-370-0745 OR CONTACT US THROUGH OUR WEB SITE,
WWW.JIMMYSTYKS.COM

FIN INSTALLATION SECTION 7

FIN INSTALLATION PROCEDURE

Insert fin, front first then lower into place until flush against bottom of fin clamp.

Insert pin through the fin clamp eyelet. Verify the fin is securely attached to the board and connecting string is securely attached to the fin before entering water.

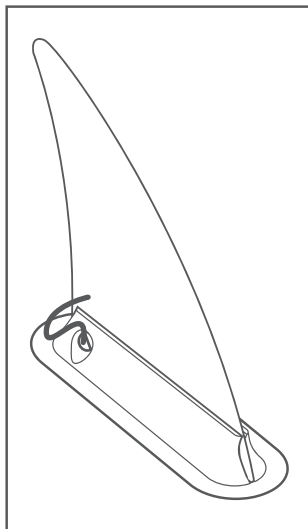
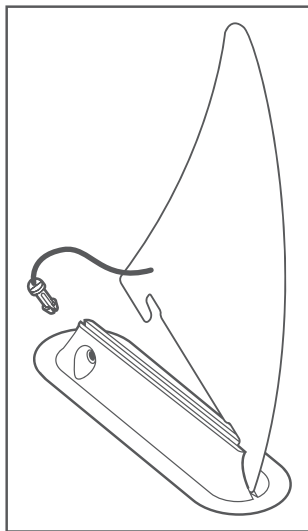

CARRY & TRANSPORT GUIDELINES

SECTION 8



DO NOT TRANSPORT AN INFLATED STAND UP PADDLE BOARD ON TOP OF A VEHICLE.

Inflatable SUPs are designed to compact for convenient storage & travel. Due to a lack of weight when inflated, they will travel poorly if strapped to a vehicle rooftop. Damages incurred by improper transport are not covered by the manufacturer's warranty!

When transporting, be sure to clear any sharp objects. Punctures are not covered by the manufacturer's warranty!

Keep clear of any heat producing items such as camp stoves, propane lamps, etc. Damages resulting from heat are not covered by the manufacturer's warranty!

Allow your Inflatable SUP to completely dry before tightly rolling for packing. Excess moisture may cause mildew and/or mold damage.



NEVER CARRY MORE THAN YOU CAN HANDLE COMFORTABLY.

The included board tote is intended for Inflatable SUP and Inflatable SUP accessories only. Additional items added to the board tote may exceed weight capacity and result in damages to the tote, shoulder straps and/or carry handle.

When completely packed, an inflatable SUP and its accessories can get rather heavy. Make sure to never carry more than is comfortable for you in one trip. Always use proper lifting and carrying techniques to avoid straining muscles.

For maximum comfort when carrying the board tote, wear both shoulder straps to evenly distribute the carry weight. Tighten the shoulder straps to reduce slack and to avoid tote contents from resting on the back of the legs.

FOR WARRANTY INFORMATION, PARTS/ACCESSORIES, CALL
1-800-370-0745 OR CONTACT US THROUGH OUR WEB SITE,
WWW.JIMMYSTYKS.COM



WEAR LATEX GLOVES TO AVOID SKIN IRRITATION.

BEFORE YOU START

Prepare the following items:

Latex Gloves (Pair)

Isopropyl Alcohol (Rubbing Alcohol)

Clean Cloth

Cement Applicator (Brush, Popsicle® stick, etc.)

RK1 Emergency Repair Kit Contents

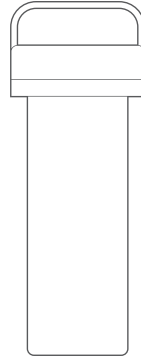

REPAIR KIT
CONTAINER

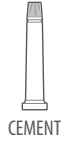

CEMENT

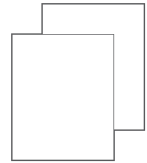

PVC/POLYESTER
PATCHES X 2

DIRECTIONS FOR USE

1. Completely deflate paddle board.
2. Thoroughly clean the surface around the leak and the matte side of the PVC/Polyester patch with rubbing alcohol. Both surfaces must be free of moisture, oil and debris.
3. Open the cement tube by breaking the tube seal using the outside of the tube cap.
4. Apply cement carefully and evenly to both paddle board surface and matte side patch surface. Avoid contact with skin & eyes. Avoid breathing cement vapors.
5. Allow cement on both board and patch to dry to the touch. Once dry, reapply a very thin layer of cement around the perimeter of the patch.
6. Once cement on both board and patch becomes tack-free, apply patch to board and firmly work out any trapped air bubbles.
7. Allow 8 hours for cement to cure before inflating paddle board.

WATER SAFETY GUIDELINES



ALWAYS WEAR A COAST GUARD APPROVED PERSONAL FLOTATION DEVICE (PFD).



NEVER GO PADDLE-BOARDING IN SEVERE WEATHER OR WATER CONDITIONS THAT MIGHT AFFECT YOUR ABILITY TO STEER THE BOARD OR RETURN TO SHORE.



NEVER ALLOW MINORS TO USE THIS BOARD WITHOUT ADULT SUPERVISION.



NEVER CONSUME ALCOHOL OR ANY OTHER SUBSTANCES THAT MAY IMPAIR YOUR COORDINATION, JUDGEMENT, OR ABILITY TO SAFELY PADDLE THE BOARD.



NEVER USE THIS BOARD BEYOND YOUR SKILLS OR ABILITY.



NEVER USE THIS PRODUCT AFTER SUNSET, BEFORE DAWN OR AT ANY TIME IN POOR LIGHTING.



CHECK LOCAL LAWS AND REGULATIONS REGARDING PROPER AND SAFE USE OF THIS PRODUCT.

FOR WARRANTY INFORMATION, PARTS/ACCESSORIES, CALL 1-800-370-0745 OR CONTACT US THROUGH OUR WEB SITE, WWW.JIMMYSTYKS.COM

LIMITED LIFETIME WARRANTY

JIMMY STYKS™ OFFERS A LIMITED 365 DAY WARRANTY AGAINST DEFECTS IN MATERIALS AND WORKMANSHIP.

TERMS OF WARRANTY:

Your Jimmy Styks™ product is guaranteed to be free of defects in material and workmanship for a period of no more than 365 days from the date of purchase. If the product does not conform to the warranty, Jimmy Styks™, at its discretion will issue a new, like new, or similar model product, excluding any shipping charges. Warranty extends to original purchaser only and is non-transferable. Sales receipt and original packaging materials are required.

WARRANTY:

Jimmy Styks™ will make every effort to produce boards to the highest quality and standards in the industry. We do quality checks in our factories in Asia and in our warehouses in North America in an effort to guarantee each board's quality before shipping. Because of the nature of surfing and paddle boarding we can not warranty the performance of any board or shape for individual riders and varying levels of skills and abilities. Furthermore, we can not guarantee against damage or breakage and can not protect or warranty against circumstances outside of our control. In the event of a new board being removed from a box and not in good condition please contact the office for resolution. You will be asked for a copy of a sales receipt and photos of the damage in question, as well as original packaging material to verify if damage was due to shipping. If it is deemed a manufacturing or material flaw, we will issue an RMA number. This number along with the damaged product will need to be returned to the closest warehouse (Vancouver or Huntington Beach) at customer's expense. Upon physical review, Jimmy Styks™ will make its final determination as to the nature of the damage or flaw and issue a replacement product (model depends on availability), or store credit. Shipping will be the responsibility of the customer. We are not responsible for damage or defects once the board has been used. Damage is defined as impact with any object or material, damage due to dropping, loading, unloading, or transport, alterations or modifications, repairs, natural disasters, fires, temperatures below 4.4 °C (40 °F), or above 43 °C (110 °F), any further use of a board once a claim has been reported, transport or storage of a board with a closed air valve, use of a board in the water with a loose or removed air valve, failure to clean and service air vent valve, storage of a board in extremely hot or humid conditions including a wet or damp board bag.

RETURNS AND EXCHANGES:

Jimmy Styks™ will exchange any new, unused product for company credit providing it is accompanied by original sales receipt and all original packaging. This will not include any shipping charges or expenses. Product must be in new condition and will be subject to the inspection of staff.

JimmyStyks.com

QUESTIONS/COMMENTS:
1-800-370-0745

NOTES

**FOR WARRANTY INFORMATION, PARTS/ACCESSORIES, CALL
1-800-370-0745 OR CONTACT US THROUGH OUR WEB SITE,
WWW.JIMMYSTYKS.COM**



JimmyStyks.com

QUESTIONS/COMMENTS:
1-800-370-0745



www.jimmystyks.com